



**BettsHD**<sup>®</sup>  
Parts for the Long Haul<sup>®</sup>

# POPULAR PARTS GUIDE



**YOUR #1 SOURCE FOR  
HEAVY DUTY  
TRUCK & TRAILER PRODUCTS**

**MADE IN THE U.S.A.**





# PARTS FOR THE LONG HAUL

# Parts, Service and Support

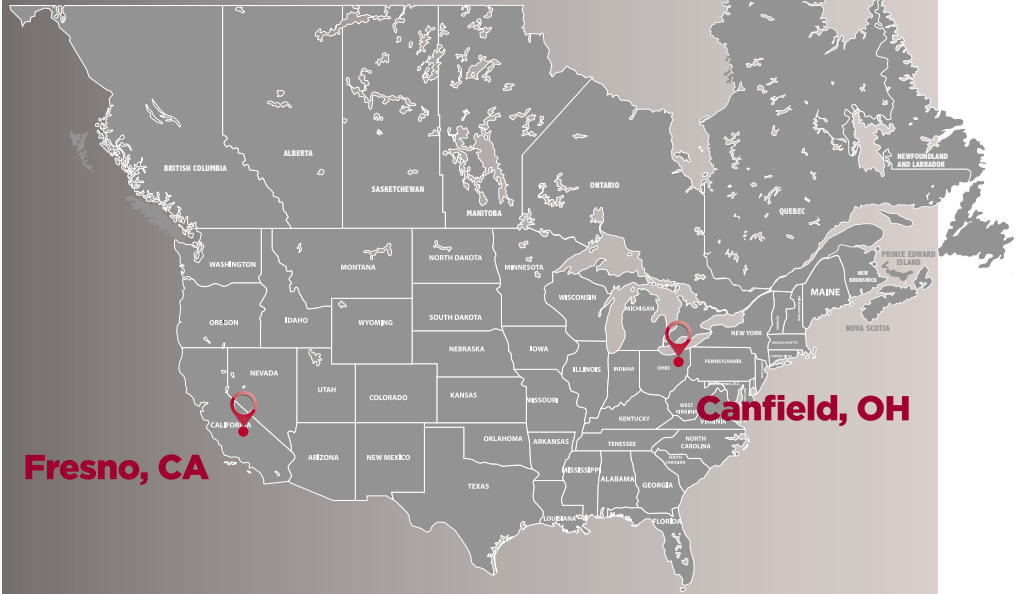

**Fresno, CA**

**Canfield, OH**

**Two strategic manufacturing and stocking locations**

## Supporting you in the marketplace and at the point of sale

BettsHD is your partner in profitability. We support the efforts of our distributors through print campaigns, POS signage, media relations and a robust website at [BettsHD.com](http://BettsHD.com).



# Ordering & Support

Contact BettsHD Customer Support for your product questions, to place an order, and to learn how to become a distributor of quality BettsHD parts.

Customer Support 559.226.9049  
8:00 AM – 8:00 PM Eastern Time  
[Customer.Support@BettsHD.com](mailto:Customer.Support@BettsHD.com)

Join Us On Social Media



# Reliability Quality Value

## Why BettsHD?

- ▶ 5 Product Categories - metal fenders, quarter fenders, poly fenders, mud flap hangers, and conspicuity
- ▶ Exceptional 98% OTD
- ▶ Responsive customer service for all product questions
- ▶ Consolidate - Save time and money ordering from a single source
- ▶ Made in U.S.A. - American made quality and reliability
- ▶ First-Fit on OEM vehicles
- ▶ Family-owned, six generations, since 1868



It's never been easier to offer your customers top quality heavy duty parts made in the U.S.A. Save time and money by ordering across 5 product categories from the one supplier that has it all with one call.

# BAR TYPE MUD FLAP HANGERS | STRAIGHT BAR



## A25RL

- **OUR BEST SELLING HANGER**
- Heavy duty .640" square spring steel
- Nominal length - 29.750"
- Unhanded design fits left or right
- Individual mud flap hanger

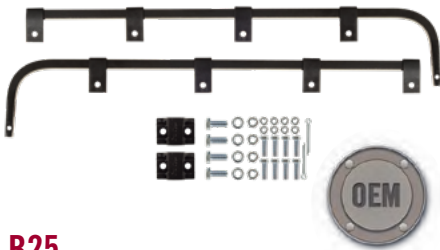

## B25

- Heavy duty .640" square spring steel
- Nominal length - 29.750"
- Unhanded design fits left or right
- Boxed kit contains two (2) A25RL hangers, two (2) B711 mounting brackets and all mounting hardware

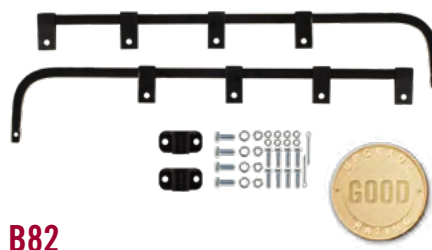

## B82

- Extra heavy duty .750" square spring steel
- Nominal length - 29.750"
- Unhanded design fits left or right
- Boxed kit contains two (2) A82RL hangers, two (2) B700 mounting brackets and all mounting hardware

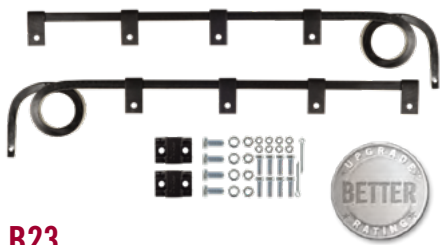

## B23

- Heavy duty .640" square spring steel
- Nominal length - 29.750"
- Both left and right hand
- Boxed kit contains one (1) A23R and one (1) A23L hanger, two (2) B711 mounting brackets and all mounting hardware

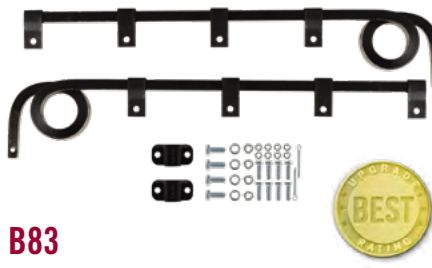

## B83

- Extra heavy duty .750" square spring steel
- Nominal length - 29.750"
- Both left and right hand
- Boxed kit contains one (1) A83R and one (1) A83L hangers, two (2) B700 mounting brackets and all mounting hardware

## A25RL BULK DISPLAYS



## A25RLB40 BULK DISPLAY

POP display barrel contains 40 A25RL mud flap hangers.



## A25RLB90 BULK DISPLAY

POP display barrel contains 90 A25RL mud flap hangers.



# OFFSET | BAR TYPE MUD FLAP HANGERS

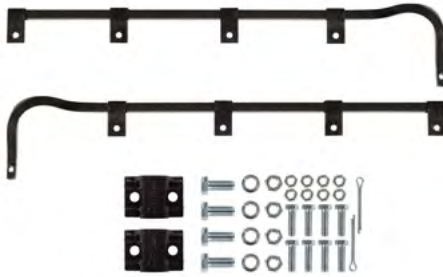

## B29

- Offset - 5.500"
- Heavy duty .640" square spring steel
- Nominal length - 29.750"
- Both left and right hand
- Boxed kit contains one (1) B29R and one (1) B29L hanger, two (2) B711 mounting brackets and all mounting hardware



## B39

- Offset - 5.500"
- Heavy duty .640" square spring steel
- Nominal length - 27.625"
- Both left and right hand
- Boxed kit contains one (1) B39R and one (1) B39L hanger, two (2) B711 mounting brackets and all mounting hardware



## B86

- Offset - 7.000"
- Extra heavy duty .750" square spring steel
- Nominal length - 25.750"
- Both left and right hand
- Boxed kit contains one (1) B86R and one (1) B86L hangers, two (2) B700 mounting brackets and all mounting hardware

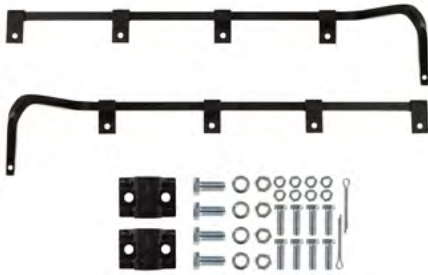

## B69

- Offset 9.000"
- Heavy duty .640" square spring steel
- Nominal length - 29.750"
- Both left and right hand
- Boxed kit contains one (1) B69R and one (1) B69L hanger, two (2) B711 mounting brackets and all mounting hardware

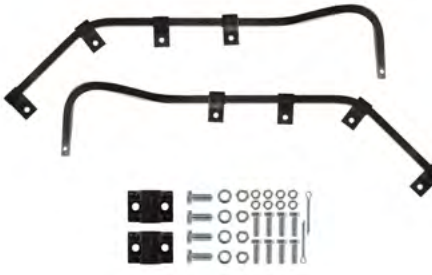

## B79

- Offset - 9.000"
- Heavy duty .640" square spring steel
- Nominal length - 27.625"
- Both left and right hand
- Boxed kit contains one (1) B79R and one (1) B79L hanger, two (2) B711 mounting brackets and all mounting hardware



## B90

- Offset: 12.000"
- Extra heavy duty .750" square spring steel
- Nominal length - 27.640"
- Both left and right hand
- Boxed kit contains one (1) B90R and one (1) B90L hangers, two (2) B700 mounting brackets and all mounting hardware

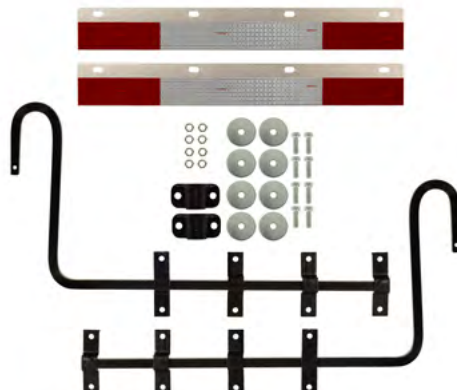

## B91

- Offset vertical 14.625"
- Heavy duty .750" square spring steel
- Nominal length - 29.750"
- Both left and right hand
- Boxed kit contains one (1) B91R and one (1) B91L hanger, two (2) B700 mounting brackets and all mounting hardware, and one skin card with two (2) RT25 conspicuity strips

# BAR TYPE MUD FLAP HANGERS | ANGLED DOWN



## A35RL

- Heavy duty .640" square spring steel
- Nominal length - 27.500"
- Unhanded design fits left or right
- Individual mud flap hanger

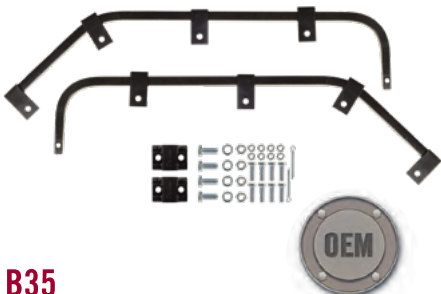

## B35

- Heavy duty .640" square spring steel
- Nominal length - 27.500"
- Unhanded design fits left or right
- Boxed kit contains two (2) A35RL hangers, two (2) B711 mounting brackets and all mounting hardware

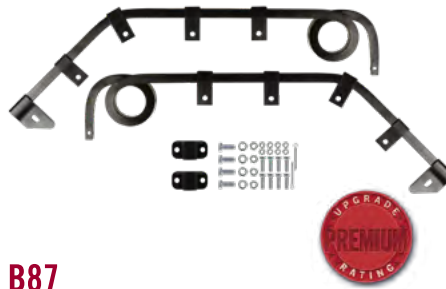

## B87

- Extra heavy duty .750" square spring steel
- Nominal length - 30.500"
- Both left and right hand
- Boxed kit contains one (1) A87R and one (1) A87L hanger, two (2) B700 mounting brackets and all mounting hardware



## B84

- Extra heavy duty .750" square spring steel
- Nominal length - 27.750"
- Both left and right hand
- Boxed kit contains one (1) A84R and one (1) A84L hanger, two (2) B700 mounting brackets and all mounting hardware

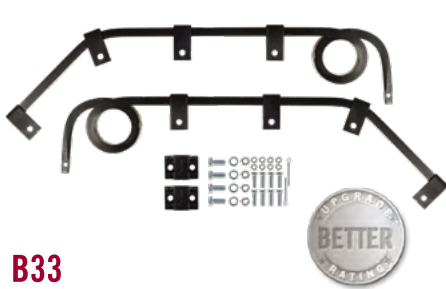

## B33

- Heavy duty .640" square spring steel
- Nominal length - 27.625"
- Both left and right hand
- Boxed kit contains one (1) A33R and one (1) A33L hanger, two (2) B711 mounting brackets and all mounting hardware

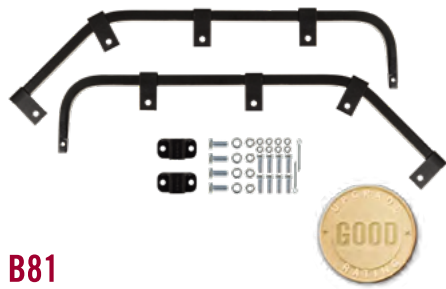

## B81

- Extra heavy duty .750" square spring steel
- Nominal length - 27.500"
- Unhanded design fits left or right
- Boxed kit contains two (2) A81RL hangers, two (2) B700 mounting brackets and all mounting hardware



## B88

- Extra heavy duty .750" square spring steel
- Nominal length - 30.500"
- Both left and right hand
- Boxed kit contains one (1) A88R and one (1) A88L hanger, two (2) B750 mounting brackets and all mounting hardware

## A35RL BULK DISPLAYS



### A35RLB40 BULK DISPLAY

POP display barrel contains 40 A35RL mud flap hangers.



### A35RLB80 BULK DISPLAY

POP display barrel contains 80 A35RL mud flap hangers.

## MUD FLAP HANGER BRACKETS



### B516P Mud Flap Mounting Kit POP Display

Counter display pail contains 50 individually packaged kits of bolts (5/16" x 1-1/4") nuts, and washers. Each kit installs one mud flap.



### B711P Bar Type Hanger Mounting Bracket POP Display

Black counter display pail contains 20 individual B711 mounting brackets



**B850**



**B1732**



**B711**



**B700**



**B600L**



**B600R**



**B650**



**B750L**



**B750R**

Part	Nominal Inside Dimension	Mounting Hole Centers	Mounting Orientation	Contents
<b>B850</b>	0.750"	3.313"	Vertical	Individual
<b>K850</b>	0.750"	3.313"	Vertical	Boxed Pair with hardware
<b>B1732</b>	0.640"	2.875"	Horizontal	Individual
<b>K1732</b>	0.640"	2.875"	Horizontal	Boxed Pair with hardware
<b>B711</b>	0.640"	1.875"	Horizontal	Individual
<b>K711</b>	0.640"	1.875"	Horizontal	Boxed Pair with hardware
<b>B700</b>	0.750"	2.875"	Horizontal	Individual
<b>K700</b>	0.750"	2.875"	Horizontal	Boxed Pair with hardware
<b>B600L</b>	0.640"	2.000"	Vertical	Individual
<b>B600R</b>	0.640"	2.000"	Vertical	Individual
<b>B650</b>	0.640"	3.313"	Vertical	Individual
<b>B750L</b>	0.750"	2.000"	Vertical	Individual
<b>B750R</b>	0.750"	2.000"	Vertical	Individual

Made from premium quality cast steel, one-piece construction.

# CONSPICUITY SOLUTIONS

DOT approved 2" x 150' conspicuity tape rolls provide increased reflectivity over standard reflective tape and are available in red and white, or standard white color options. We also offer our white or red white conspicuity tape with 3-, 5- or 10-year durability options.

## 3 YEAR DURABILITY



### RTR103

Colors: 11" Red, 7" White

### RTR203

Colors: 6" Red, 6" White

## 5 YEAR DURABILITY

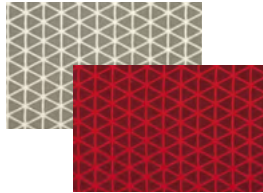

### RTR105

Colors: 11" Red, 7" White

### RTR205

Colors: 6" Red, 6" White

### RTR305

Color: White

## 10 YEAR DURABILITY

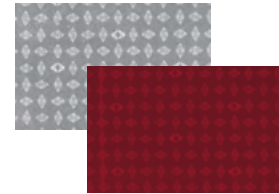

### RTR110

Colors: 11" Red, 7" White

### RTR210

Colors: 6" Red, 6" White

### RTR310

Color: White



### RT25

Skin card display package contains two (2) RT25RL conspicuity strips for use with straight bar or spring loaded hangers. Unhanded design fits both left and right. Lightweight aluminum construction.

- Can be ordered individually, unpackaged (RT25RL)



### RT35

Skin card display packaging contains one (1) RT35R and one (1) RT35L conspicuity strip for use with angled bar or spring loaded hangers. Lightweight aluminum construction

- Both left and right side
- Can be ordered individually, unpackaged (RT35R or RT35L)

### RT25RL

Individual, unpackaged conspicuity strip for use with straight bar or spring loaded hangers. Unhanded design fits both left and right. Lightweight aluminum construction.



### RT35L

Individual, unpackaged conspicuity strip for use with angled bar or spring loaded hangers. Fits left side. Lightweight aluminum construction.

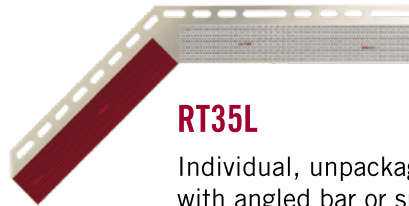

### RT35R

Individual, unpackaged conspicuity strip for use with angled bar or spring loaded hangers. Fits right side. Lightweight aluminum construction.

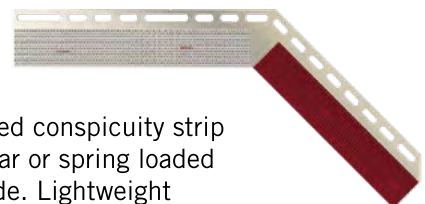



# SPRING LOADED MUD FLAP HANGERS



## B572825NTBK

- Mounting stud centers - 1.125"
- Nominal length - 28.250"
- Powder coated carbon steel
- Both left and right hand
- Boxed kit includes (1) LH and (1) RH hanger, stud nuts and mud flap mounting hardware



## B573025NTSK

- Mounting stud centers - 1.125"
- Nominal length - 30.250"
- Bright 430 stainless steel
- Both left and right hand
- Boxed kit includes (1) LH and (1) RH hanger, stud nuts and mud flap mounting hardware



## B573025WTBK

- Mounting stud centers - 1.125"
- Nominal length - 30.250"
- Powder coated carbon steel
- Both left and right hand
- Boxed kit includes (1) LH and (1) RH hanger, stud nuts and mud flap mounting hardware



## B672625NTBK

- Mounting stud centers - 1.125"
- Nominal length - 26.250"
- Powder coated carbon steel
- Both left and right hand
- Boxed kit includes (1) LH and (1) RH hanger, stud nuts and mud flap mounting hardware

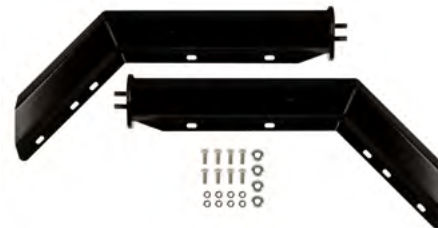

## B672825NTBK

- Mounting stud centers - 1.125"
- Nominal length - 28.250"
- Powder coated carbon steel
- Both left and right hand
- Boxed kit includes (1) LH and (1) RH hanger, stud nuts and mud flap mounting hardware



## B673025NTBK

- Mounting stud centers - 1.125"
- Nominal length - 30.250"
- Powder coated carbon steel
- Both left and right hand
- Boxed kit includes (1) LH and (1) RH hanger, stud nuts and mud flap mounting hardware



## B673025WTBK

- Mounting stud centers - 1.125"
- Nominal length - 30.250"
- Powder coated carbon steel
- Both left and right hand
- Boxed kit includes (1) LH and (1) RH hanger, stud nuts and mud flap mounting hardware



## B703000NTBK

- Mounting stud centers - 2.500"
- Nominal length - 30.000"
- Powder coated carbon steel
- Both left and right hand
- Boxed kit includes (1) LH and (1) RH hanger, stud nuts and mud flap mounting hardware



## B703000NTSK

- Mounting stud centers - 2.500"
- Nominal length - 30.000"
- Bright 430 stainless steel
- Both left and right hand
- Boxed kit includes (1) LH and (1) RH hanger, stud nuts and mud flap mounting hardware

# SINGLE ARM HANGERS

Individual arms offer the flexibility of single hanger replacement. Single arm options are Unhanded and can be used as left or right.



## M673025NTBU

- Mounting stud centers - 1.125"
- Nominal length - 30.250"
- Powder coated carbon steel
- Unhanded design fits both left and right
- Boxed kit includes (1) Unhanded hanger, stud nuts and mud flap mounting hardware



## M703000NTSU

- Mounting stud centers - 2.500"
- Nominal length - 30.000"
- Bright 430 stainless steel
- Unhanded design fits both left and right
- Boxed kit includes (1) Unhanded hanger, stud nuts and mud flap mounting hardware



## M703000NTBU

- Mounting stud centers - 2.500"
- Nominal length - 30.000"
- Powder coated carbon steel
- Unhanded design fits both left and right
- Boxed kit includes (1) Unhanded hanger, stud nuts and mud flap mounting hardware

## OPTIONAL STUD SPACING

Optional stud spacing offers solutions for all popular mounting hole options. Our most popular styles are available with alternate stud spacing.



## B683025WTBK

- Mounting stud centers - 2.500"
- Nominal length - 30.250"
- Powder coated carbon steel
- Both left and right hand
- Boxed kit includes (1) LH and (1) RH hanger, stud nuts and mud flap mounting hardware



## B713000NTSK

- Mounting stud centers - 1.125"
- Nominal length - 30.000"
- Bright 430 stainless steel
- Both left and right hand
- Boxed kit includes (1) LH and (1) RH hanger, stud nuts and mud flap mounting hardware

## Smart™ Part Numbering System

See page 27 to use our unique Smart™Part numbering system to determine the appropriate part number for your application.

Visit [BettsHD.com](http://BettsHD.com) to view all spring loaded hanger options

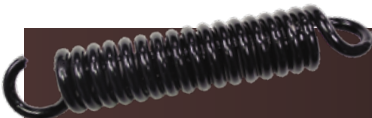

### Open Wound Coil Spring

Our proprietary, corrosion-resistant spring within every BettsHD spring loaded mud flap hanger delivers unrivaled spring yield performance for quick mud flap recentering and recovery.



### Integrated Self-Centering Tombstone

Corrosion-resistant self-centering tombstone works with our open wound coil spring to provide maximum horizontal deflection, protecting your frame and hanger in the event of a collision.

# DIRECTFLEX™ MUD FLAP RETENTION SYSTEM

In 1999, BettsHD introduced DirectFlex® Mud Flap Retention System - the only patented mud flap retention system on the market. With no moving components, the system is nearly maintenance free. **Three black powder coated mounting bracket options** accommodate all popular installation configurations.

DirectFlex™ Mud Flap Retention System is compatible with standard mud flaps and ChannelFlap™ mud flaps.

## DIRECTFLEX™ STRAIGHT ARM

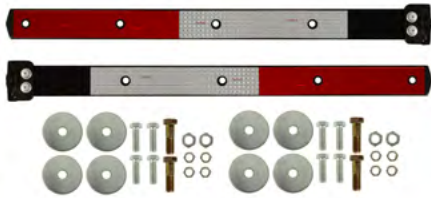

**DF25PB901**

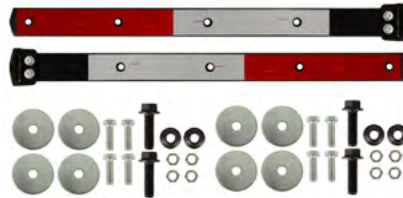

**DF25PB931**

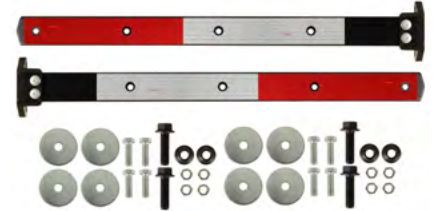

**DF25PB941**

Overall Length	Mounting Centers	Mounting Orientation	Handedness	Packaging	Kit Part Number
25.00"	1.12" / 1.18" / 2.50" / 3.31"	Vertical	Both	Boxed - Kit	DF2525G-941
30.25"	1.12" / 1.18" / 2.50" / 3.31"	Vertical	Both	Boxed - Kit	DF25PB-941
30.25"	1.88"	Horizontal	Both	Boxed - Kit	DF25PB-901
30.25"	2.88"	Horizontal	Both	Boxed - Kit	DF25PB-931
29.00"	2.88"	Horizontal	Both	Boxed - Kit	DF2529PB-931
29.00"	1.12" / 1.18" / 2.50" / 3.31"	Vertical	Both	Boxed - Kit	DF2529PB-941
25.00"	1.12" / 1.18" / 2.50" / 3.31"	Vertical	Unhanded	Boxed - Individual	DM2525G-941
30.25"	1.88"	Horizontal	Unhanded	Boxed - Individual	DM25PB-901
30.25"	2.88"	Horizontal	Unhanded	Boxed - Individual	DM25PB-931
30.25"	1.12" / 1.18" / 2.50" / 3.31"	Vertical	Unhanded	Boxed - Individual	DM25PB-941

G = Galvanized Version PB = Powder Coated Black Version

### The DirectFlex™ Solution

Visit Resources on BettsHD.com to watch DirectFlex™ installation and performance videos.



### STRAIGHT CHANNELFLAP™

The ChannelFlap™ heavy-duty poly mud flap encapsulates the DirectFlex™ hanger. The compression fit between the components results in a minimum **3X stronger** connection when compared to any traditional mud flap and mud flap hanger combination.



**CF25RL30PB**

- Straight / full width
- 30" long
- Unhanded design fits both left and right
- Individual mud flap

# DIRECTFLEX™ MUD FLAP RETENTION SYSTEM

## DIRECTFLEX™ ANGLED ARM



**DF3526PB901**

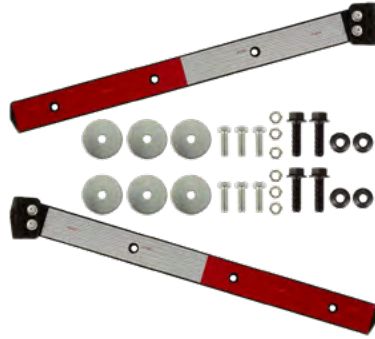

**DF3526PB931**



**DF3526PB941**

Overall Length	Mounting Centers	Mounting Orientation	Handedness	Packaging	Kit Part Number
26.00"	1.12" / 1.18" / 2.50" / 3.31"	Vertical	Both	Boxed - Kit	DF3526PB-941
26.00"	1.88"	Horizontal	Both	Boxed - Kit	DF3526PB-901
26.00"	2.88"	Horizontal	Both	Boxed - Kit	DF3526PB-931
26.00"	1.88"	Horizontal	Left Hand	Boxed - Individual	DM3526LPB-901
26.00"	2.88"	Horizontal	Left Hand	Boxed - Individual	DM3526LPB-931
26.00"	1.12" / 1.18" / 2.50" / 3.31"	Vertical	Left Hand	Boxed - Individual	DM3526LPB-941
26.00"	1.88"	Horizontal	Right Hand	Boxed - Individual	DM3526RPB-901
26.00"	2.88"	Horizontal	Right Hand	Boxed - Individual	DM3526RPB-931
26.00"	1.12" / 1.18" / 2.50" / 3.31"	Vertical	Right Hand	Boxed - Individual	DM3526RPB-941

## DIRECTFLEX™ MOUNTING BRACKETS

See **Kit Part Number** in Straight and Angled charts to reference mounting bracket configuration for DirectFlex™ kits.



**-901**



**-931**



**-941**

## ANGLED CHANNELFLAP™



**CF3526LH24PB**

- Angled / corner cut
- 24" long
- Left hand
- Individual mud flap



**CF3526RH24PB**

- Angled / corner cut
- 24" long
- Right hand
- Individual mud flap



**CF3526LH30PB**

- Angled / corner cut
- 30" long
- Left hand
- Individual mud flap



**CF3526RH30PB**

- Angled / corner cut
- 30" long
- Right hand
- Individual mud flap

# TRAILER MUD FLAP RETENTION SYSTEM (TMF-RS)



**GO FROM THIS...**



**TO THIS...**



**OR THIS...**

**Virtually ELIMINATE trailer mud flap loss**

**Install & repair with common hand tools**

**NO MORE WELDING - Makes roadside or driver repair possible**

## **TRSD10NT**

**Trailer Mud Flap Retention System with DirectFlex®**

Conspicuity: Without

Slider Width: 48"

Handedness: Pair

Durability: Severe Duty Premium



## **TRSD10WT**

**Trailer Mud Flap Retention System with DirectFlex®**

Conspicuity: With

Slider Width: 48"

Handedness: Pair

Durability: Severe Duty Premium



## **TRBS10NT**

**Trailer Mud Flap Retention System Spring Loaded Hangers**

Conspicuity: Without

Slider Width: 48"

Handedness: Pair

Durability: Heavy Duty Standard



## **TRBS10WT**

**Trailer Mud Flap Retention System Spring Loaded Hangers**

Conspicuity: With

Slider Width: 48"

Handedness: Pair

Durability: Heavy Duty Standard



“ True to the claims, TMF-RS, with its specially designed mounting bracket, has our fleet of trailers looking top notch and in compliance.

Gone are the days of bent angle iron or missing mud flaps. BettsHD and TMF-RS will be a mainstay here at Charlie's Produce. ”

Ian L. - Charlie's Produce Fleet Maintenance Manager



Watch TMF-RS in action at [BettsHD.com/bettshd-training-videos](http://BettsHD.com/bettshd-training-videos)

# POLY QUARTER FENDERS



**PS211PA2**  
STANDARD MOUNT PAIR



**PS221PA2**  
LOW MOUNT PAIR



**PS211PA5**  
STANDARD MOUNT  
RIGHT SIDE

**PS211PA6**  
STANDARD MOUNT  
LEFT SIDE



**PS221PA5**  
LOW MOUNT  
RIGHT SIDE

**PS221PA6**  
LOW MOUNT  
LEFT SIDE

<b>Material</b>	Black UV resistant poly panel
<b>Mounting Tube</b>	Black, e-coat, 18-gauge carbon steel mounting tube
<b>Clamp</b>	AccuSeal™ aluminized carbon steel tube clamp
<b>Includes</b>	Black poly top flat with zinc plated steel top flap hardware
<b>Packaging</b>	Assembled box kit, includes tube mounting clamps, top flaps and top flap mounting hardware

## QUARTER FENDER ACCESSORIES

### X2900 MOUNTING POST

Eight inches (8") long single bolt post. Individually packaged.



### ACCUSEAL™ CLAMPS

- 400118-00 aluminized version for galvanized mounting tubes
- 400118-01 stainless steel version for stainless steel mounting tubes
- BettsHD exclusive



**400118-00**



**400118-01**



**100109-00 BLACK RUBBER**



**100144-00 BLACK POLY**



**100145-00 WHITE POLY**

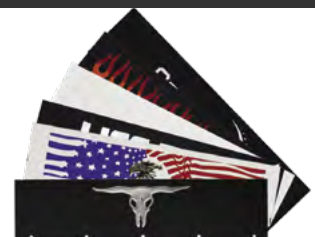

### LOGO TOP FLAPS

Popular stock logos available: Eagle, Flame and Longhorn. Custom logos available; minimum quantity applies.

# STAINLESS STEEL QUARTER FENDERS



**SS211PA2**  
STANDARD MOUNT PAIR



**SS221PA2**  
LOW MOUNT PAIR



**SS211PA5**  
STANDARD MOUNT  
RIGHT SIDE

**SS211PA6**  
STANDARD MOUNT  
LEFT SIDE



**SS221PA5**  
LOW MOUNT  
RIGHT SIDE

**SS221PA6**  
LOW MOUNT  
LEFT SIDE



**SS241PA2**  
ULTRA LOW MOUNT PAIR



**PS241PA5**  
ULTRA LOW MOUNT  
RIGHT SIDE

**PS241PA6**  
ULTRA LOW MOUNT  
LEFT SIDE

<b>Material</b>	Bright 430 18-gauge stainless steel
<b>Mounting Tube</b>	18-gauge stainless steel with stainless steel end cap
<b>Clamp</b>	AccuSeal™ stainless steel tube clamp
<b>Includes</b>	Black poly top flat with stainless steel top flap hardware
<b>Packaging</b>	Assembled box kit, includes tube mounting clamps, top flaps and top flap mounting hardware

# POLY FENDERS

## SINGLE AXLE

### PF200-68

<b>Material</b>	Black high density UV resistant poly
<b>Style</b>	3-Rib Up with radiused edge
<b>Overall Length</b>	68"
<b>Fender Opening</b>	46"
<b>Wheel Size</b>	22.5" and 24.5"
<b>Application</b>	Dual wheels
<b>Mounting Kit</b>	K2363UG fender mounting kit recommended, not included
<b>Additional Options</b>	16.5" and 19.5" wheel sizes - see options on page 17



PF200-68

### TIKPF200-68P

Total Installation Kit (TIK) contains **PF200-68** fenders (pair) plus **K2363UG** fender mounting kit



TIKPF200-68P

### PF200-80

<b>Material</b>	Black high density UV resistant poly
<b>Style</b>	3-Rib Up with radiused edge
<b>Overall Length</b>	80"
<b>Fender Opening</b>	50"
<b>Wheel Size</b>	22.5" and 24.5"
<b>Application</b>	Dual wheels
<b>Mounting Kit</b>	K2363UG fender mounting kit recommended, not included
<b>Additional Options</b>	16.5" and 19.5" wheel sizes - see options on page 17



PF200-80

### TIKPF200-80P

Total Installation Kit (TIK) contains **PF200-80** fenders (pair) plus **K2363UG** fender mounting kit



TIKPF200-80P



# HALF TANDEM AXLE

## PF300-57

<b>Material</b>	Black high density UV resistant poly
<b>Style</b>	3-Rib Up with radiused edge
<b>Overall Length</b>	57"
<b>Front Curve</b>	30"
<b>Flat Section</b>	27"
<b>Fender Opening</b>	48"
<b>Wheel Size</b>	22.5" and 24.5"
<b>Application</b>	Dual wheels
<b>Mounting Kit</b>	K3363UG fender mounting kit recommended, not included



PF300-57

## TIKPF300-57P

Total Installation Kit (TIK) contains **PF300-57** fenders (pair) plus **K3363UG** fender mounting kit



TIKPF300-57P

## PF300-66

<b>Material</b>	Black high density UV resistant poly
<b>Style</b>	3-Rib Up with radiused edge
<b>Overall Length</b>	66"
<b>Front Curve</b>	39"
<b>Flat Section</b>	27"
<b>Fender Opening</b>	51"
<b>Wheel Size</b>	22.5" and 24.5"
<b>Application</b>	Dual wheels
<b>Mounting Kit</b>	K3363UG fender mounting kit recommended, not included



PF300-66

## TIKPF300-66P

Total Installation Kit (TIK) contains **PF300-66** fenders (pair) plus **K3363UG** fender mounting kit



TIKPF300-66P

# POLY FENDERS

## FULL TANDEM AXLE

### PF400-114X

<b>Material</b>	Black high density UV resistant poly
<b>Style</b>	3-Rib Up with radiused edge
<b>Overall Length</b>	114"
<b>Front Curve</b>	30"
<b>Flat Section</b>	54"
<b>Rear Curve</b>	30"
<b>Fender Opening</b>	96"
<b>Wheel Size</b>	22.5" and 24.5"
<b>Application</b>	Dual wheels
<b>Mounting Kit</b>	K4363UG fender mounting kit recommended, not included



PF400-114X

### TIKPF400-114XP

Total Installation Kit (TIK) contains **PF400-114** fenders (pair) plus **K4363UG** fender mounting kit



TIKPF400-114XP

### PF400-132X

<b>Material</b>	Black high density UV resistant poly
<b>Style</b>	3-Rib Up with radiused edge
<b>Overall Length</b>	132"
<b>Front Curve</b>	39"
<b>Flat Section</b>	54"
<b>Rear Curve</b>	39"
<b>Fender Opening</b>	105"
<b>Wheel Size</b>	22.5" and 24.5"
<b>Application</b>	Dual wheels
<b>Mounting Kit</b>	K4363UG fender mounting kit recommended, not included



PF400-132X

### TIKPF400-132XP

Total Installation Kit (TIK) contains **PF400-132X** fenders (pair) plus **K4363UG** fender mounting kit



TIKPF400-132XP

# SPECIALTY FENDERS

## PF100-52

<b>Material</b>	Black high density UV resistant poly
<b>Style</b>	3-Rib Up with radiused edge
<b>Overall Length</b>	52"
<b>Fender Opening</b>	42"
<b>Wheel Size</b>	16.5"
<b>Application</b>	Single wheel
<b>Mounting Kit</b>	K2263UG fender mounting kit recommended, not included. Tubes may need to be shortened depending on application



PF100-52

## PF100-60

Not shown. Overall Length 60"; Fender Opening 46"; Wheel Size 19.5"

## POLY MODULAR SECTIONS & ACCESSORIES

### PF40

Black high density UV resistant poly. Front or rear curve for modular configuration. Overall length - 40"



### PF51

Black high density UV resistant poly flat section. Overall length - 51"

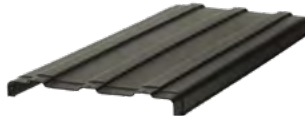

### P4H-1

Carriage bolt hardware kit connects PF40 and PF51 fender sections. Zinc plated steel

### PF400H-1

Cap screw and strap kit connects poly fender sections. Galvanized steel



## MOUNTING KITS



K2363UG



K3363UG



K4363UG

Mounting Kit	Center Mounts	Tubes / Caps	U-Bolts	Hardware
<b>K2363UG</b>	N/A	<ul style="list-style-type: none"> <li>Four (4) T363UG single-bolt frame mount, undrilled galvanized tubes</li> <li>Four (4) CP12 poly end caps</li> </ul>	Four (4) P100H-1 galvanized U-bolt hardware kits: each contains three (3) U-bolts, lock nuts and washer plates	N/A
<b>K3363UG</b>	Two (2) B900G single-bolt frame mounts, .625" through-hole with 3½" vertical adjustability	<ul style="list-style-type: none"> <li>Two (2) T363UG single-bolt frame mount, undrilled galvanized tubes</li> <li>Two (2) CP12 poly end caps</li> </ul>	Two (2) P100H-1 galvanized U-bolt hardware kits: each contains three (3) U-bolts, lock nuts and washer plates	Two (2) B4H-1: each contains five (5) carriage bolts, nuts, flat and lock washers
<b>K4363UG</b>	Two (2) B900G single-bolt frame mounts, .625" through-hole with 3½" vertical adjustability	<ul style="list-style-type: none"> <li>Four (4) T363UG single-bolt frame mount, undrilled galvanized tubes</li> <li>Four (4) CP12 poly end caps</li> </ul>	Four (4) P100H-1 galvanized U-bolt hardware kits: each contains three (3) U-bolts, lock nuts and washer plates	Two (2) B4H-1: each contains five (5) carriage bolts, nuts, flat and lock washers

# METAL FENDERS | 4 RIB STAINLESS STEEL

## SINGLE AXLE

### SR200-80

<b>Material</b>	Bright 430 18 gauge stainless steel
<b>Style</b>	4-Rib with beaded edge
<b>Overall Length</b>	80"
<b>Fender Opening</b>	50"
<b>Wheel Size</b>	22.5" and 24.5"
<b>Application</b>	Dual wheels
<b>Packaging</b>	Cardboard wrapped pair
<b>Mounting Kit</b>	K2362PS fender mounting kit recommended, not included
<b>Additional Options</b>	60" overall length Galvanized carbon steel or aluminum



SR200-80



TIKSR200-80DS

### TIKSR200-80DS

Total Installation Kit (TIK) contains **SR200-80** fenders (pair) plus **K2362PS** fender mounting kit

## HALF TANDEM AXLE

### SR300-66

<b>Material</b>	Bright 430 18 gauge stainless steel
<b>Style</b>	4-Rib with beaded edge
<b>Overall Length</b>	66"
<b>Front Curve</b>	39"
<b>Flat Section</b>	27"
<b>Fender Opening</b>	51"
<b>Wheel Size</b>	22.5" and 24.5"
<b>Application</b>	Dual wheels
<b>Packaging</b>	Cardboard wrapped pair with SF100H rubber vibration isolators
<b>Mounting Kit</b>	K3362PS fender mounting kit recommended, not included
<b>Additional Options</b>	60" and 80" overall lengths Galvanized carbon steel or aluminum



SR300-66



TIKSR300-66DS

### TIKSR300-66DS

Total Installation Kit (TIK) contains **SR300-66** fenders (pair) plus **K3362PS** fender mounting kit

# FULL TANDEM AXLE

## SR400-126

<b>Material</b>	Bright 430 18 gauge stainless steel
<b>Style</b>	4-Rib with beaded edge
<b>Overall Length</b>	126"
<b>Front Curve</b>	39"
<b>Rear Curve</b>	33"
<b>Flat Section</b>	54"
<b>Fender Opening</b>	104"
<b>Wheel Size</b>	22.5" and 24.5"
<b>Application</b>	Dual wheels
<b>Packaging</b>	Cardboard wrapped pair with SF100H rubber vibration isolators
<b>Mounting Kit</b>	K4362PS fender mounting kit recommended, not included
<b>Additional Options</b>	105", 120" and 132" overall lengths Galvanized carbon steel or aluminum



SR400-126

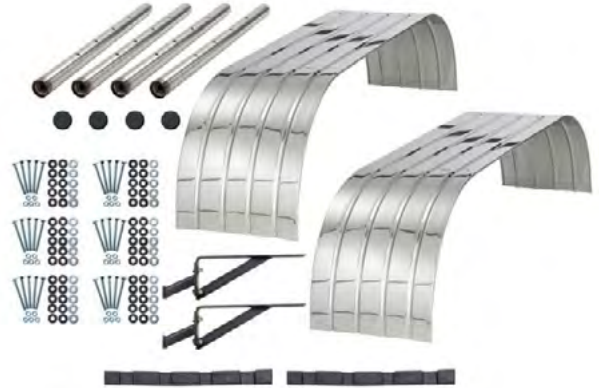

TIKSR400-126DS

## TIKSR400-126DS

Total Installation Kit (TIK) contains **SR400-126** fenders (pair) plus **K4362PS** fender mounting kit

## MOUNTING KITS



K2362PS



K3362PS



K4362PS



B900S



T362PS

Mounting Kit	Center Mounts	Tubes / Caps	Hardware
<b>K2362PS</b>	N/A	<ul style="list-style-type: none"> <li>Four (4) T362PS single-bolt frame mount, 30" predrilled Stainless Steel tubes</li> <li>Four (4) CP12 poly end caps</li> </ul>	Four (4) B4HS-1 stainless steel carriage bolt kits: each contains five (5) carriage bolts, nuts, flat and lock washers
<b>K3362PS</b>	Two (2) B900S single-bolt frame mounts, .625" through-hole with 3½" vertical adjustability	<ul style="list-style-type: none"> <li>Two (2) T362PS single-bolt frame mounts, 30" predrilled Stainless Steel tubes</li> <li>Two (2) CP12 poly end caps</li> </ul>	Four (4) B4HS-1 stainless steel carriage bolt kits: each contains five (5) carriage bolts, nuts, flat and lock washers
<b>K4362PS</b>	Two (2) B900S single-bolt frame mounts, .625" through-hole with 3½" vertical adjustability	<ul style="list-style-type: none"> <li>Four (4) T362PS single-bolt frame mounts, 30" predrilled Stainless Steel tubes</li> <li>Four (4) CP12 poly end caps</li> </ul>	Six (6) B4HS-1 stainless steel carriage bolt kits: each contains five (5) carriage bolts, nuts, flat and lock washers
<b>B900S</b>	<ul style="list-style-type: none"> <li>Single-bolt frame mount, .625" through-hole with 3½" vertical adjustability.</li> <li>Unhanded - Fits right or left</li> </ul>	N/A	One (1) B4HS-1 stainless steel carriage bolt kit: each contains five (5) carriage bolts, nuts, flat and lock washers
<b>T362PS</b>	N/A	<ul style="list-style-type: none"> <li>Single-bolt frame mount, 30" predrilled Stainless Steel tube</li> <li>CP12 poly end cap</li> </ul>	One (1) B4HS-1 stainless steel carriage bolt kit: each contains five (5) carriage bolts, nuts, flat and lock washers

# METAL FENDERS | 2 RIB STAINLESS STEEL

## SINGLE AXLE

### SR200-80NL

<b>Material</b>	Bright 430 18 gauge stainless steel
<b>Style</b>	2-Rib with beaded edge
<b>Overall Length</b>	80"
<b>Fender Opening</b>	51"
<b>Wheel Size</b>	22.5" and 24.5"
<b>Application</b>	Dual wheels
<b>Packaging</b>	Cardboard wrapped pair
<b>Mounting Kit</b>	K2362PS fender mounting kit recommended, not included
<b>Additional Options</b>	60" overall length Galvanized carbon steel

### TIKSR200-80NLDS

Total Installation Kit (TIK) contains **SR200-80NL** fenders (pair) plus **K2362PS** fender mounting kit



SR200-80NL



TIKSR200-80NLDS

## HALF TANDEM AXLE

### SR300-66NL

<b>Material</b>	Bright 430 18 gauge stainless steel
<b>Style</b>	2-Rib with beaded edge
<b>Overall Length</b>	66"
<b>Front Curve</b>	39"
<b>Flat Section</b>	27"
<b>Fender Opening</b>	51"
<b>Wheel Size</b>	22.5" and 24.5"
<b>Application</b>	Dual wheels
<b>Packaging</b>	Cardboard wrapped pair with SF100H rubber vibration isolators
<b>Mounting Kit</b>	K3362PS fender mounting kit recommended, not included
<b>Additional Options</b>	60" and 80" overall lengths Galvanized carbon steel

### TIKSR300-66NLDS

Total Installation Kit (TIK) contains **SR300-66NL** fenders (pair) plus **K3362PS** fender mounting kit

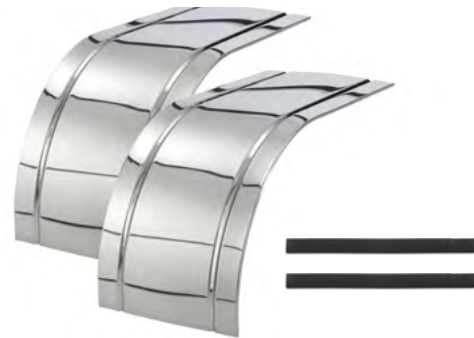

SR300-66NL



SR300-66NLDS

# FULL TANDEM AXLE

## SR400-126NL

<b>Material</b>	Bright 430 18 gauge stainless steel
<b>Style</b>	2-Rib with beaded edge
<b>Overall Length</b>	126"
<b>Front Curve</b>	39"
<b>Rear Curve</b>	33"
<b>Flat Section</b>	54"
<b>Fender Opening</b>	104"
<b>Wheel Size</b>	22.5" and 24.5"
<b>Application</b>	Dual wheels
<b>Packaging</b>	Cardboard wrapped pair with SF100H rubber vibration isolators
<b>Mounting Kit</b>	K4362PS fender mounting kit recommended, not included
<b>Additional Options</b>	105", 120" and 132" overall lengths Galvanized carbon steel

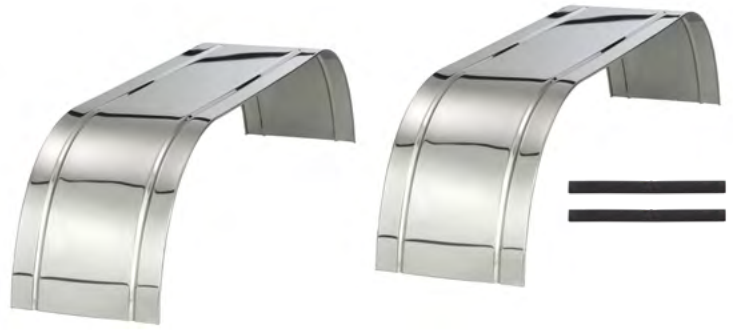

SR400-126NL



TIKSR400-126NLDS

## TIKSR400-126NLDS

Total Installation Kit (TIK) contains **SR400-126** fenders (pair) plus **K4362PS** fender mounting kit

## MOUNTING KITS



K2362PS



K3362PS



K4362PS



B900S



T362PS

Mounting Kit	Center Mounts	Tubes / Caps	Hardware
<b>K2362PS</b>	N/A	<ul style="list-style-type: none"> <li>Four (4) T362PS single-bolt frame mount, 30" predrilled stainless steel tubes</li> <li>Four (4) CP12 poly end caps</li> </ul>	Four (4) B4HS-1 stainless steel carriage bolt kits: each contains five (5) carriage bolts, nuts, flat and lock washers
<b>K3362PS</b>	Two (2) B900S single-bolt frame mounts, .625" through-hole with 3½" vertical adjustability	<ul style="list-style-type: none"> <li>Two (2) T362PS single-bolt frame mounts, 30" predrilled stainless steel tubes</li> <li>Two (2) CP12 poly end caps</li> </ul>	Four (4) B4HS-1 stainless steel carriage bolt kits: each contains five (5) carriage bolts, nuts, flat and lock washers
<b>K4362PS</b>	Two (2) B900S single-bolt frame mounts, .625" through-hole with 3½" vertical adjustability	<ul style="list-style-type: none"> <li>Four (4) T362PS single-bolt frame mounts, 30" predrilled stainless steel tubes</li> <li>Four (4) CP12 poly end caps</li> </ul>	Six (6) B4HS-1 stainless steel carriage bolt kits: each contains five (5) carriage bolts, nuts, flat and lock washers
<b>B900S</b>	<ul style="list-style-type: none"> <li>Single-bolt frame mount, .625" through-hole with 3½" vertical adjustability.</li> <li>Unhanded - Fits right or left</li> </ul>	N/A	One (1) B4HS-1 stainless steel carriage bolt kit: each contains five (5) carriage bolts, nuts, flat and lock washers
<b>T362PS</b>	N/A	<ul style="list-style-type: none"> <li>Single-bolt frame mount, 30" predrilled Stainless Steel tube</li> <li>CP12 poly end cap</li> </ul>	One (1) B4HS-1 stainless steel carriage bolt kit: each contains five (5) carriage bolts, nuts, flat and lock washers

# METAL FENDERS | SMOOTH STAINLESS STEEL

## SINGLE AXLE

### TS28000000

<b>Material</b>	Bright 430 16 gauge stainless steel
<b>Style</b>	Smooth with radiused edge
<b>Overall Length</b>	80"
<b>Fender Opening</b>	50"
<b>Wheel Size</b>	22.5" and 24.5"
<b>Application</b>	Dual wheels
<b>Packaging</b>	Cardboard wrapped pair
<b>Mounting Kit</b>	L200TS fender mounting kit recommended, not included



TS28000000

### TIKT80000

Total Installation Kit (TIK) contains **TS28000000** fenders (pair) plus **L200TS** fender mounting kit



TIKT800000

## HALF TANDEM AXLE

### TS33902700

<b>Material</b>	Bright 430 16 gauge stainless steel
<b>Style</b>	Smooth with radiused edge
<b>Overall Length</b>	66"
<b>Front Curve</b>	39"
<b>Flat Section</b>	27"
<b>Fender Opening</b>	51"
<b>Wheel Size</b>	22.5" and 24.5"
<b>Application</b>	Dual wheels
<b>Packaging</b>	Cardboard wrapped pair with SF200H rubber vibration isolators
<b>Mounting Kit</b>	U300TS fender mounting kit recommended, not included
<b>Additional Options</b>	66" overall length with 35" front curve and 31" flat section



TS33902700

### TIKT392700

Total Installation Kit (TIK) contains **TS33902700** fenders (pair) plus **U300TS** fender mounting kit



TIKT392700

## SPECIALTY FENDERS

Visit [BettsHD.com](http://BettsHD.com) for smooth stainless steel specialty fenders.



TS80100141



TS80100139



# FULL TANDEM AXLE

## TS43905439

<b>Material</b>	Bright 430 16 gauge stainless steel
<b>Style</b>	Smooth with radiused edge
<b>Overall Length</b>	132"
<b>Front Curve</b>	39"
<b>Rear Curve</b>	39"
<b>Flat Section</b>	54"
<b>Fender Opening</b>	105"
<b>Wheel Size</b>	22.5" and 24.5"
<b>Application</b>	Dual wheels
<b>Packaging</b>	Cardboard wrapped pair with SF200H rubber vibration isolators
<b>Mounting Kit</b>	U400TS fender mounting kit recommended, not included
<b>Additional Options</b>	120" overall length



TS43905439



TIKT395439

## TIKT395439

Total Installation Kit (TIK) contains **TS43905439** fenders (pair) plus **U400TS** fender mounting kit

## MOUNTING KITS



L400TS



U300TS



U400TS

Mounting Kit	Mounts / Posts	Tubes / Caps / Clamps	Bolt Kit
<b>L400TS</b>	<ul style="list-style-type: none"> <li>Four (4) X2900 single-bolt posts</li> </ul>	<ul style="list-style-type: none"> <li>Four (4) B610TS stainless steel paddle brackets</li> <li>Four (4) 400118-01 AccuSeal stainless steel clamps</li> </ul>	<ul style="list-style-type: none"> <li>Four (4) TS100H-1 hardware kits: each kit contains three (3) strap plates, six (6) cap screws and six (6) flat washers</li> </ul>
<b>U300TS</b>	<ul style="list-style-type: none"> <li>Two (2) B900S single-bolt frame mounts, .625" through-hole with 3-1/2" vertical adjustability</li> <li>Two (2) X2900 single-bolt posts</li> </ul>	<ul style="list-style-type: none"> <li>Two (2) B610TS stainless steel paddle brackets</li> <li>Two (2) 400118-01 AccuSeal stainless steel clamps</li> </ul>	<ul style="list-style-type: none"> <li>Two (2) TS100H-1 hardware kits: each kit contains three (3) strap plates, six (6) cap screws and six (6) flat washers</li> <li>Two (2) B4HS-1 stainless steel carriage bolt kits: each contains five (5) carriage bolts, nuts, flat and lock washers</li> </ul>
<b>U400TS</b>	<ul style="list-style-type: none"> <li>Two (2) B900S single-bolt frame mounts, .625" through-hole with 3-1/2" vertical adjustability</li> <li>Four (4) X2900 single-bolt posts</li> </ul>	<ul style="list-style-type: none"> <li>Four (4) B610TS stainless steel paddle brackets</li> <li>Four (4) 400118-01 AccuSeal stainless steel clamps</li> </ul>	<ul style="list-style-type: none"> <li>Four (4) TS100H-1 hardware kits: each kit contains three (3) strap plates, six (6) cap screws and six (6) flat washers</li> <li>Two (2) B4HS-1 stainless steel carriage bolt kits: each contains five (5) carriage bolts, nuts, flat and lock washers</li> </ul>

# METAL FENDERS | STAINLESS STEEL CORRUGATED

## SINGLE AXLE

### MS200-80

<b>Material</b>	Bright 430 18 gauge stainless steel
<b>Style</b>	Corrugated
<b>Overall Length</b>	80"
<b>Fender Opening</b>	50"
<b>Wheel Size</b>	22.5" and 24.5"
<b>Application</b>	Dual wheels
<b>Packaging</b>	Cardboard wrapped pair
<b>Mounting Kit</b>	K2362US fender mounting kit recommended, not included
<b>Additional Options</b>	60" overall length Galvanized carbon steel



MS200-80



MS300-66

## FULL TANDEM AXLE

### MS400-132

<b>Material</b>	Bright 430 18 gauge stainless steel
<b>Style</b>	Corrugated
<b>Overall Length</b>	132"
<b>Front Curve</b>	39"
<b>Rear Curve</b>	33"
<b>Flat Section</b>	54"
<b>Fender Opening</b>	104"
<b>Wheel Size</b>	22.5" and 24.5"
<b>Application</b>	Dual wheels
<b>Packaging</b>	Cardboard wrapped pair
<b>Mounting Kit</b>	K4362US fender mounting kit recommended, not included
<b>Additional Options</b>	105", 120" and 126" overall lengths Galvanized carbon steel

## HALF TANDEM AXLE

### MS300-66

<b>Material</b>	Bright 430 18 gauge stainless steel
<b>Style</b>	Corrugated
<b>Overall Length</b>	66"
<b>Front Curve</b>	39"
<b>Flat Section</b>	27"
<b>Fender Opening</b>	51"
<b>Wheel Size</b>	22.5" and 24.5"
<b>Application</b>	Dual wheels
<b>Packaging</b>	Cardboard wrapped pair
<b>Mounting Kit</b>	K3362US fender mounting kit recommended, not included
<b>Additional Options</b>	60" and 80" overall lengths Galvanized carbon steel



MS400-132



## LOAD LOCK

### Secure Your Load!

The Load Lock Holder is a lockable, anti-theft storage system that easily mounts nearly anywhere on your tractor to safeguard your load lock bars when not in use.

Each load lock is individually cradled to ensure no movement — neither side to side, nor up and down.

Load Locks safely secure 1-1/2" and/or 1-5/8" bars and also accommodate 2" x 4" and/or 4" x 4" pads.

PART #: LLH401

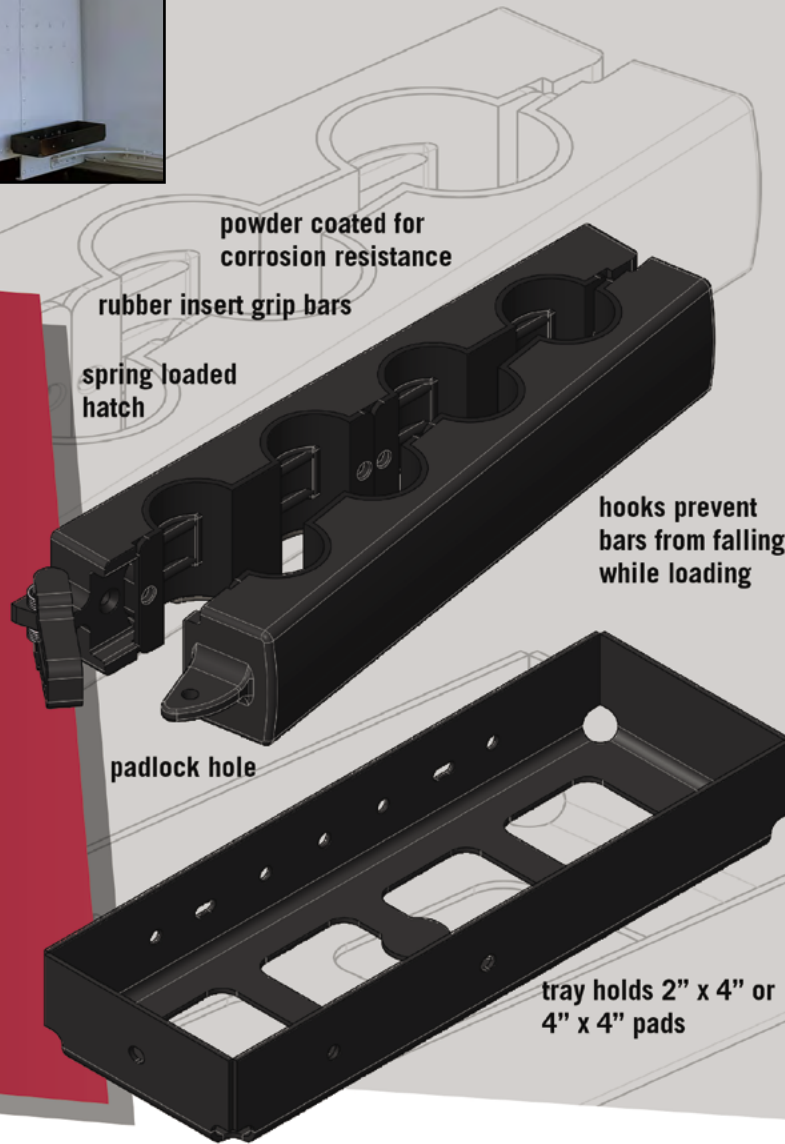

### Security

Prevent unsecure load citations. The lockable anti-theft safety system easily mounts nearly anywhere on your truck to safeguard your load locks when not in use.



### Safety

Easy to install system, prevent damage to cab fairing and quarter fenders from side-to-side conventional storage.



### Benefits

- OEM quality, heavy-duty aluminum for long life.
- Powder coated to resist corrosion.
- Hinged clamp secures load braces & eliminates the need for rubber straps.

# FENDER MEASUREMENTS GUIDE

## Custom Sizes

Determine curving dimensions using illustration models  
Available for all metal fenders except smooth, radiused  
Mounting brackets and installation hardware available separately



### SINGLE AXLE

**A** (Overall Length) = \_\_\_\_\_ in inches

**B** (Opening) = \_\_\_\_\_ in inches



### HALF TANDEM

**A** (Front Curve) = \_\_\_\_\_ in inches

**B** (Flat) = \_\_\_\_\_ in inches



### FULL TANDEM

**A** (Front Curve) = \_\_\_\_\_ in inches

**B** (Flat) = \_\_\_\_\_ in inches

**C** (Rear Curve) = \_\_\_\_\_ in inches

## FENDER MEASUREMENTS GUIDE

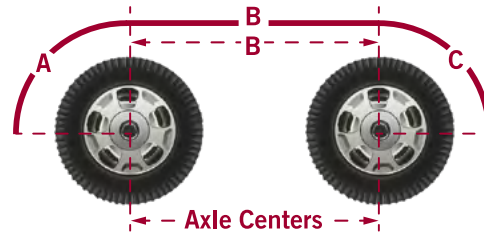
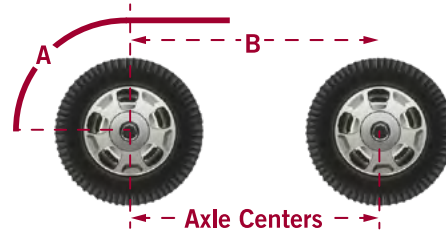
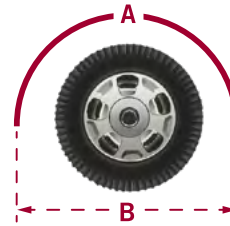

## SPRING LOADED MUD FLAP HANGERS

Use the chart below to determine the appropriate part number for your application.  
A value from each column is required, but not all combinations are valid part numbers.

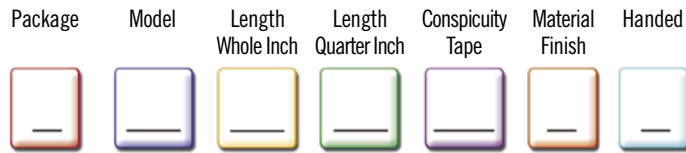

Example –

**B 67 30 25 WT B K**

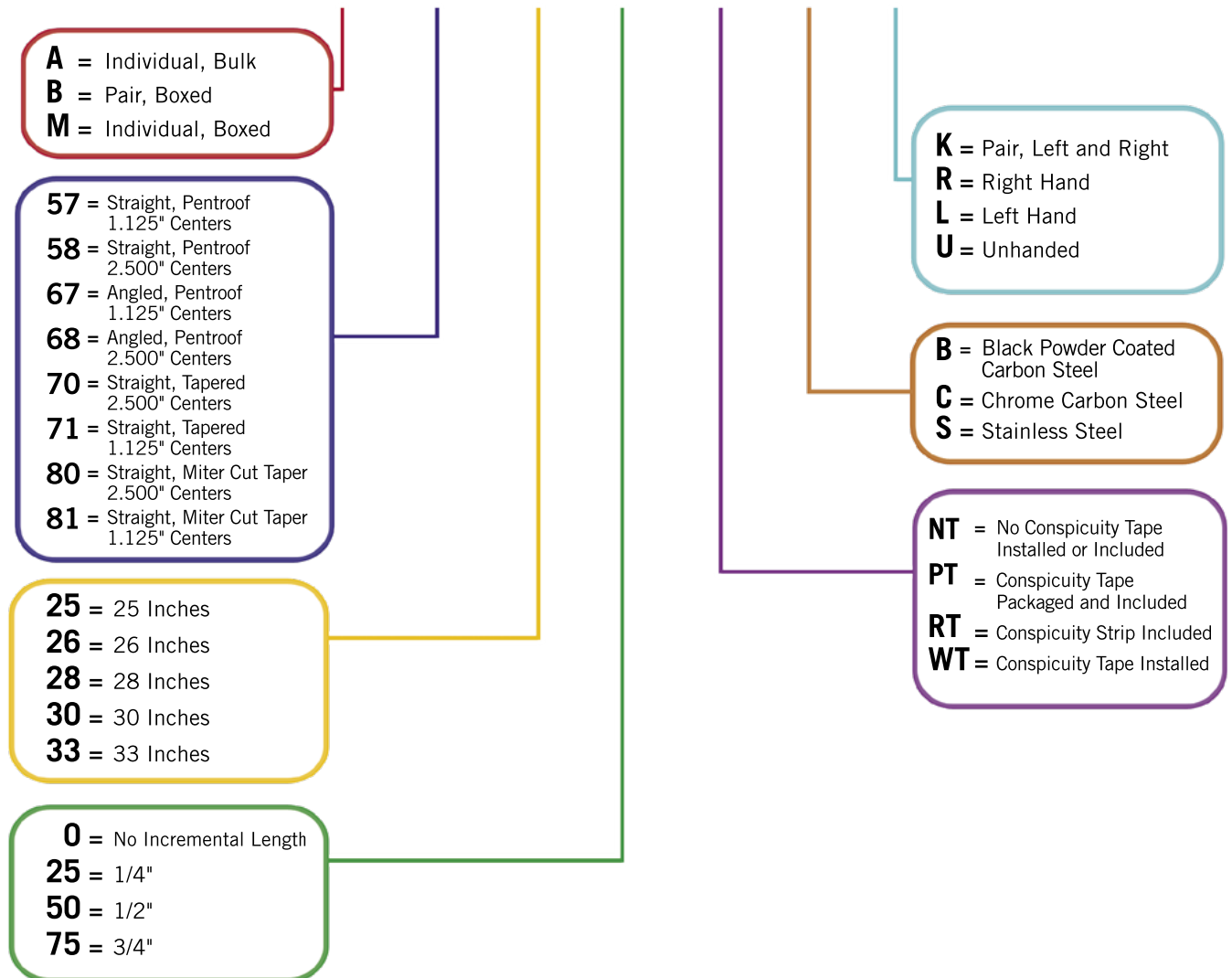

# SMART™ PART NUMBERING SYSTEM

## QUARTER FENDERS

Use the chart below to determine the appropriate part number for your application.  
A value from each column is required, but not all combinations are valid part numbers.

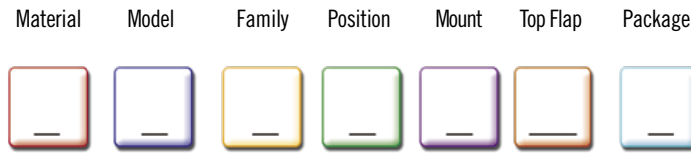

Example – **P S 2 1 1 PA 2**

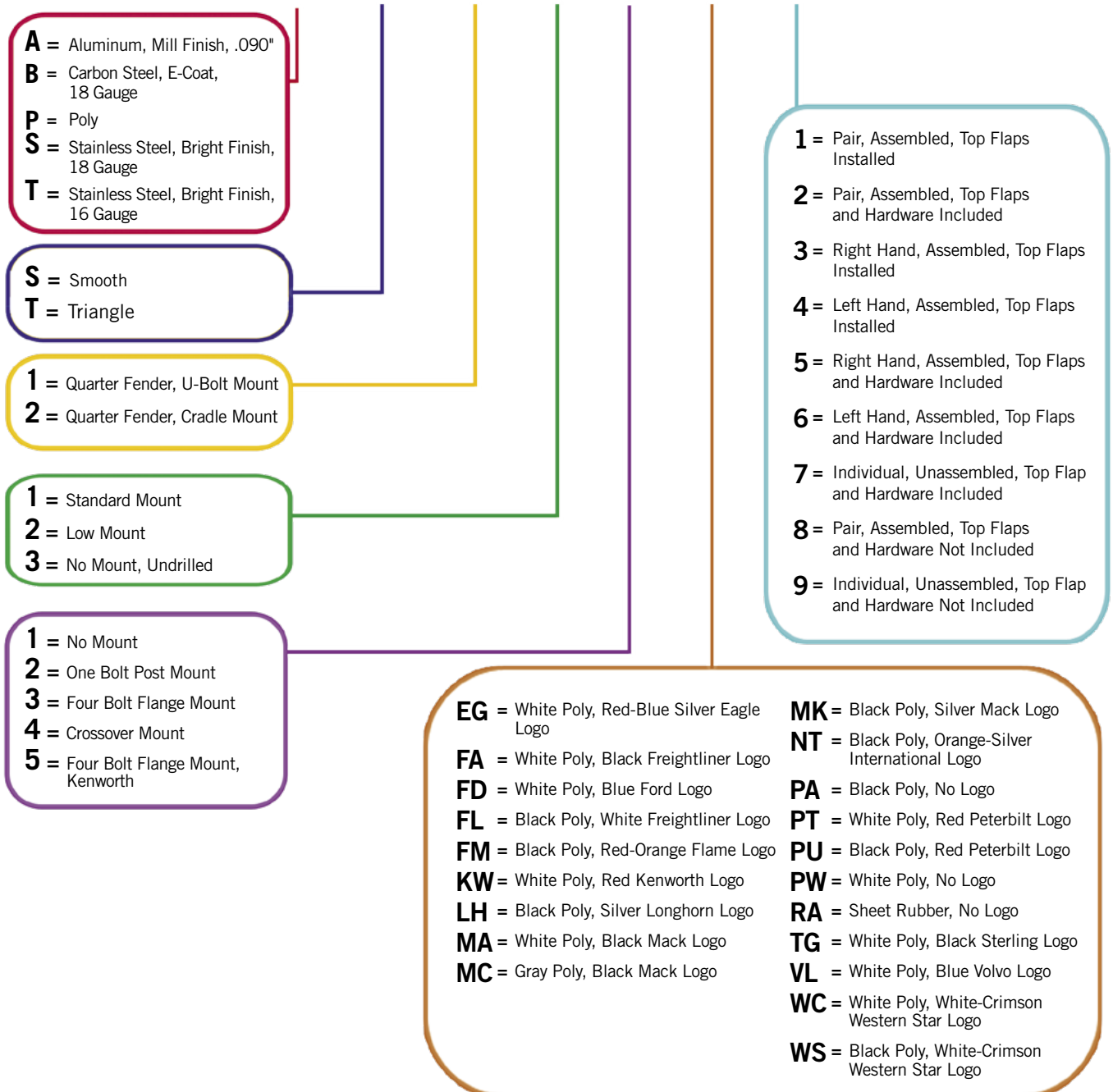

## FENDER MOUNTING KITS

Use the chart below to determine the appropriate part number for your application.  
A value from each column is required, but not all combinations are valid part numbers.

### KITS

Example –

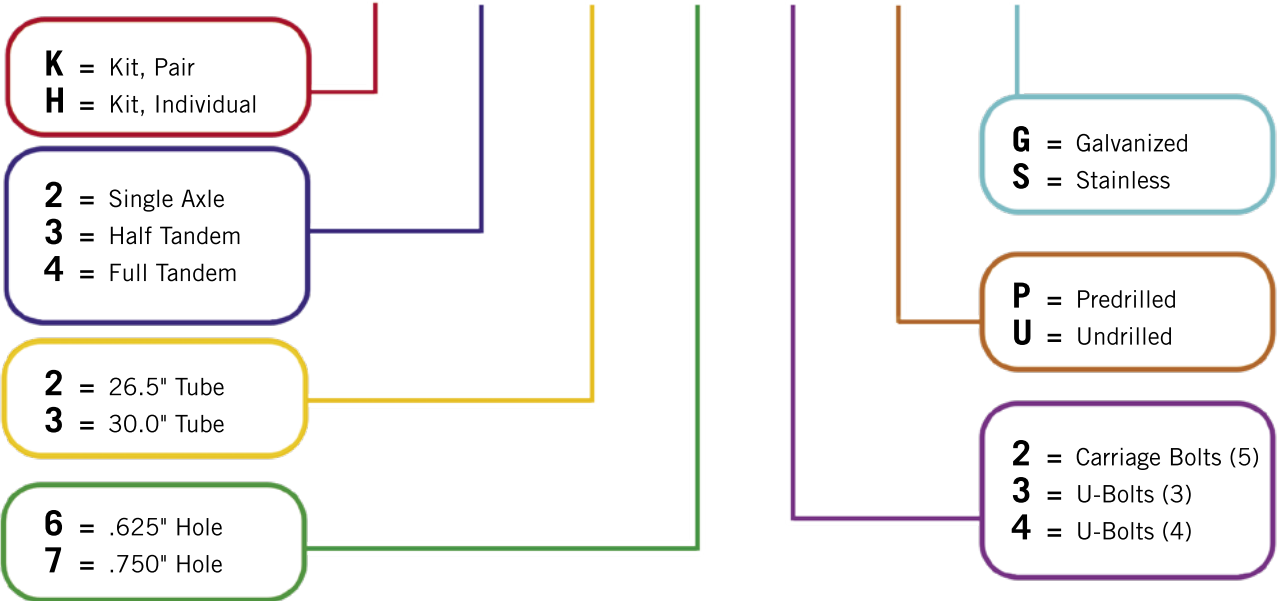
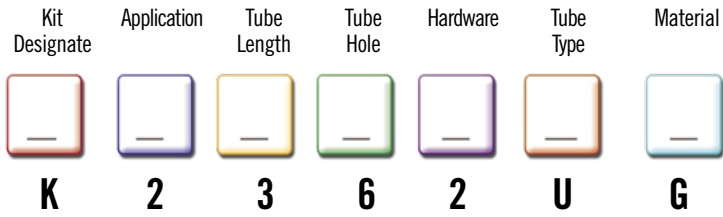

### TUBES

Example –

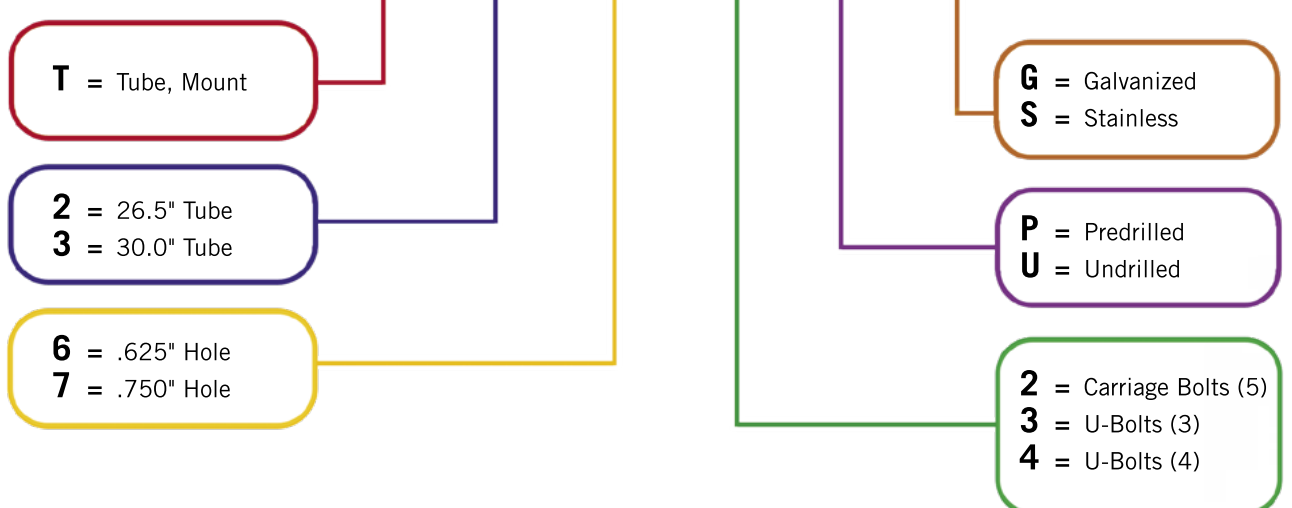
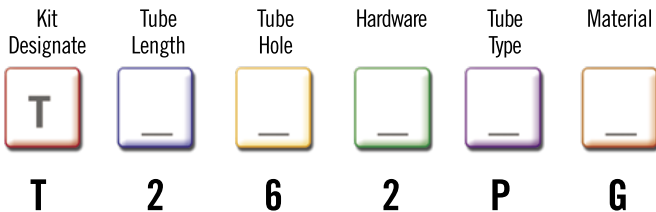



**BettsHD**

Fresno, CA | Canfield, OH

**Ph. 559.226.9049**

**Fax 559.441.0087**

[Customer.Support@BettsHD.com](mailto:Customer.Support@BettsHD.com)

Follow Us On Social Media



A proud division of

